

PHOTOGRAPHIC CANADIANA

JOURNAL OF THE PHOTOGRAPHIC HISTORICAL SOCIETY OF CANADA

Volume 32, Number 3

ISSN 0704-0024

Dec. 2006 - Jan. 2007

Date of Issue - December 2006

Canada Post Canadian Publications Mail Sales Product Agreement No. 40050299

Postage Paid at Toronto

Photographic Canadiana is published quarterly (except July and August) by The Photographic Historical Society of Canada, 6021 Yonge Street, Box 239, Toronto, Ontario, M2M 3W2.

Photographic Canadiana does not pay for articles or photographs; all functions of PHSC are based on voluntary participation. Manuscripts or articles should be sent to the Editor and will be returned if requested.

Views expressed in this publication solely reflect the opinions of the authors, and do not necessarily reflect the views of PHSC.

For Back Issues

For back issues and single copies: order directly from the Librarian, whose name and address appear on page 3. Current copies are \$4.00 each. A subscription is included in membership fee which is \$24.00 a year. Toronto area fee is \$32.00 which includes meetings. Back issues of Vols. I & II are available at \$2.00 per copy, Vols. III to VIII (inclusive) at \$3.00 per copy. The Vol. 25 #2 *Special Anniversary* issue costs \$12.00. Other back issues are \$4.00 per copy.

Writing for PC Journal

To publicize events, notices, advertising, writing articles or requesting information already published in *Photographic Canadiana* please write directly to the Editor at 18 Ashfield Drive, Etobicoke, Ont., Canada, M9C 4T6. Telephone/fax (416) 621-8788 or E-mail to: bob.lansdale@1staccess.ca

ACCESS THE PHSC

via e-mail
info@phsc.ca

CHECK FOR PHOTOGRAPHIC NEWS & PROGRAM UPDATES

<http://www.phsc.ca>

Robert A. Carter – Webmaster

IN THIS ISSUE

- | | | | |
|----|---|----|--|
| 2 | PC Index
Our Cover | 16 | A Photographic Tour of
PhotoHistory XIII in Rochester
–Robert Lansdale |
| 3 | President's Message
The Society, Executive and
PC Editorial Board | 18 | Toronto Notes: October 2006
meeting – Lesley Sparks
–Robert Carter |
| 3 | Notice of Nominations 2007-09 | 19 | The Daguerreian Symposium
in Pittsburg
–Robert Lansdale |
| 4 | Camera Designs of
Walter Dorwin Teague
–Ralph London and Rick Soloway | 20 | Taking Colour Photographs
with a 100 Year Old Kodak
–Alldyn Clark |
| 13 | "Canadian Made"
Teague Era Cameras
–Robert Lansdale | | PC Supplement Sheet |
| 14 | Browsing through our Exchanges
–George Dunbar | 1 | Schedule for December 2006
and January 2007 |
| 15 | Touring The PHSC Fall Fair
–Mark Singer | 2 | Coming Events & Want Ads |

OUR COVER

When *Modernism* blossomed in the 1930s, Eastman Kodak in Rochester hired industrial designer Walter Dorwin Teague to guide them in decorating their cameras in the "new" style. It led to a complete line of outer packaging, face plates and cover plates in bright colours. It starts on page 4.

Teague had his hand also in designing and shaping new cameras which were making use of pressure molded bakelite plastic.

Bill and John Kantymir have searched out packaging that differs to the American products. Page 13 shows the Kantymir collection. ♣



President's Message

Ed Warner



PORTRAIT BY ROBERT LANSDALE

Seasons Greetings!

How are you all doing? Maybe for the coming year you will receive new photographic-related collectibles or perhaps find research information of interest to other members of the PHSC. Please tell us about it by email or phone, or in person at one of our regular meetings. We sincerely want to hear about this material.

The executive board tabulated the returned votes and found: 87 IN FAVOUR, 13 AGAINST, with 3 SPOILED, making a total of 103 ballots returned. Thus, the proposal to increase the membership dues in the forthcoming year is approved.

Effective May 1, 2007, the dues will, for "national" membership, be \$32.00 per year while for "Toronto" membership, (those attending Toronto meetings) the dues will be raised to \$35.00 per year, BUT only taking effect as of May 2008.

On the topic of membership Wayne Gilbert, Membership Secretary, informed the executive that over the past couple years some 140 expired memberships had failed to renew. They will be receiving a new notice and we hope they will RENEW. We encourage everyone to help bring in new members.

You can look forward to our PHSC ANNUAL AUCTION being held in the early spring; final details will be announced in our newsletters.

A handwritten signature in black ink, appearing to read 'Ed Warner'.

ED WARNER, PRESIDENT
telephone 905-436-9387

Call for Nominations for PHSC Executive Officers for 2007 – 2009

At the Annual meeting of the PHSC to be held April 18, 2007 a new slate of officers will take up its mandate. Nominations for positions on the executive must be signed by two members in good standing, must be signed by the person being nominated and must be received by the PHSC office by February 18, 2007.

The positions to be filled are President, 1st Vice President, 2nd Vice President, Treasurer, Recording Secretary, Membership Secretary, Program Director and Curator.

All other positions are appointed by the executive.

THE PHOTOGRAPHIC HISTORICAL SOCIETY OF CANADA

6021 Yonge Street, Box 239,
Toronto, Ontario, M2M 3W2

Telephone (416) 691-1555
Fax (416) 693-0018
<http://www.phsc.ca>
e-mail: info@phsc.ca

The PHSC was founded in Toronto in 1974 for people interested in photographic history. It was incorporated as a non-profit organization in Canada four years later. All activities are undertaken by unpaid volunteers.

We help camera and image collectors and those interested in the diverse aspects of photographic history, sharing in their enthusiasm and knowledge.

We promote public interest in photographic history through talks, awards, publications, fairs and auctions.

The majority of our 250 members are camera or image collectors, photographic researchers & writers, and professional photographers in Canada. Included are many libraries, archives, museums and other photographic societies.

Board of Directors 2005–2007

President	<i>Ed Warner</i>
Past President	<i>Mike Robinson</i>
1st Vice President	<i>Robert Carter</i>
2nd Vice President	<i>Clint Hryhorijiw</i>
Secretary	<i>Tiit Kõdar</i>
Treasurer	<i>Werner Drechsel</i>
Membership Sect'y	<i>Wayne Gilbert</i>
Programme	<i>Felix Russo</i>
Curator	<i>Mark Singer</i>

Librarian	<i>Gerald Loban</i>
64 Fonthill Blvd., Unionville, ON., L3R 1V7	
C. Stereo Coll'n Coordinator	<i>Stan White</i>
Chairman Spring/Fall Fair	<i>Mark Singer</i>
Ass't Fair Chairman	<i>Clint Hryhorijiw</i>
Financial Controller	<i>John Linsky</i>
Publ'n & Research Awards	<i>Mike Robinson</i>
Webmaster	<i>Robert A. Carter</i>

PC Editor	<i>Robert E. Lansdale</i>
18 Ashfield Dr., Etobicoke, Ont., M9C 4T6	
NEW e-mail:	bob.lansdale@1staccess.ca

Contributing Editors

Bill Belier
George Dunbar
Everett Roseborough
Robert G. Wilson
Stanley J. White

PC Distribution *Robert G. Wilson*

We are privileged to present here new research into the history of photography. A condensed version of this article was premiered at the PhotoHistory XIII Symposium in Rochester, N.Y. October 21, 2006, by authors London and Soloway under the title: *Walter Dorwin Teague: Master American Camera Designer*. – editor R.L.

Camera Designs of Walter Dorwin

by Ralph London and Rick Soloway

Entering the 1900s Art Nouveau held sway in the art community with its wavy leaf designs, superfluous decoration and Belle Epoque sentiments. Advancing into the 20th century new “isms” took root to challenge those concepts. Fauvism, Cubism, Futurism, and Expressionism emerged after the lull and devastation of the First World War.

The 1925 ‘Exposition Internationale des Arts Decoratifs et Industriels Modernes’ provided the origin of the term ‘Art Deco.’ It was this exhibition that first showed the new style of design in applied arts and architecture that grabbed the world’s imagination. Modernism was the description applied in America with bold cleaner architecture, streamlined trains and industrial designed furniture. Not all could afford the high-priced newness but could enjoy smaller amenities bearing the new designs such as cigarette cases, household decorations, newly developed radios, electric refrigerators and of course cameras.
– editor

Industrial designer Walter Dorwin Teague designed many attractive cameras for the Eastman Kodak Company starting as early as the late 1920s. Our Teague exploration reveals four categories of “Teague cameras”: generally accepted Teague designs, surprise Teagues, possible Teagues and not Teagues. In some instances, co-designers emerged, previously unrecognized as such. We begin with a short account of Teague’s early career which led to the pivotal meeting with a Kodak official. The company turned out to be a lifelong client of Teague’s.

Prior to Kodak

The odyssey of Walter Dorwin Teague from his rural Midwestern roots as the son of a Methodist circuit preacher, to becoming the dean of American Modernism and industrial design, was as remarkable as it was unlikely. Born in Decatur, Indiana, on December 18, 1883, Teague left tiny Pendleton, Indiana, in 1903, a year after graduating from its local high school, bound for New York City to study art. Not a child of privilege, Teague checked hats at the YMCA, lettered signs for the Y itself and drew items for mail-order catalogs to support night classes at the Art Students League during 1903-1907.

After working for two advertising agencies, Teague opened his own office in 1911 to do freelance decorative designs and typography for advertising agencies and publishers of books and magazines. His sign-making experience and natural talent as a draftsman led to a career in commer-

cial art, illustration and typography. Teague’s earliest recognition as an authority came in typography. His classic typographic borders appeared in his ads and came to be known universally as “Teague borders,” whether done by him or others. They are in his commissioned design in 1923 of the format for *Time* covers.

Attracted by innovations in architecture and product design, Teague traveled to Europe in 1926. Taking inspiration from the modern designs of Walter Gropius and the Bauhaus Movement and from the book *Vers une Architecture* (the English version is *Towards a New Architecture*) by French architect Charles Eduard Jeanneret (better known by his pseudonym Le Corbusier), Teague returned to New York City determined to become an industrial designer himself. Encouragement also came from clients who were seeking his advice about the design of their products. Adding “industrial design” to his let-

A Teague designed border from 1923.

Teague

terhead in 1926, he established under his own name (what is believed to be) the first industrial design firm in the U.S. The name changed in 1951 to Walter Dorwin Teague Associates.

Retained by Kodak

In the mid-1920s George Eastman decided that the current line of Kodak cameras, all black, needed modernizing and an improved appearance. In 1927 he dispatched Adolph Stuber to New York City to hire a designer or artist for the job. Stuber, a Kodak vice president and son of Kodak's president William Stuber, obtained a list of potential candidates, including Teague, from the Metropolitan Museum of Art's Richard F. Bach. By all accounts Teague was the only person Stuber contacted. At the end of the day's discussions, Stuber suggested that Teague work for Kodak. Teague, with commitments in New York and acknowledging knowing nothing about cameras, was unsure about designing them.

Shortly thereafter Teague responded by letter, agreeing to spend one week a month in Rochester, starting January 1, 1928, for \$15,000 per year. (One inflation calculator suggests \$15,000 in 1928 corresponds to about \$160,000 in 2006.) Teague also insisted on a drawing board as close as possible to Engineering. Incomplete work



Walter Dorwin Teague

started in Rochester would be completed in New York, then sent to Kodak and reviewed the following month. Teague deemed it essential that he study and become familiar with the materials and processes used in camera manufacturing, and that he work closely with Kodak engineers. [see *References*: 1,8,10,12]

Kodak was one of Teague's earliest clients and his first major industrial client. Their nearly thirty-three year relationship ended at his death on December 5, 1960, just short of his 77th birth-

day. The oldest of his three children, Walter Dorwin Teague, Jr. (1910-2004), recognized the significance of the relationship when he wrote in his 1998 autobiography: "My father had stipulated a very substantial fee for the times. This was a smart move as it not only insured that his opinion would be respected, but it set the pattern for subsequent Eastman assignments and for dealing with other clients. With the success of the Baby Brownie [a Teague 1934 design], the future of my father's industrial design business was assured." [11, p. 22]

Teague, Jr., who was known as "Dorwin Teague" and also "W. Dorwin Teague," happened to work for Kodak during the summer of 1929 at \$25 a week. In a job arranged by his father, Dorwin redid the ink drawings for parts in response to change orders as problems appeared or cheaper methods were developed. Thus, during this short time, there were two Walter Dorwin Teagues working for Kodak!



George Eastman on a *Time* magazine cover decorated with a Teague border.

CONTINUED NEXT PAGE



Adolph Stuber cover 1926

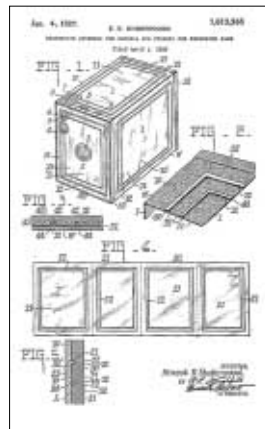

Underwood covering 1926

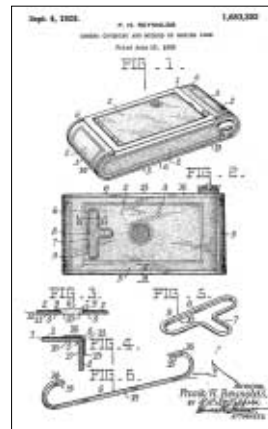

Frank Reynolds covering 1926

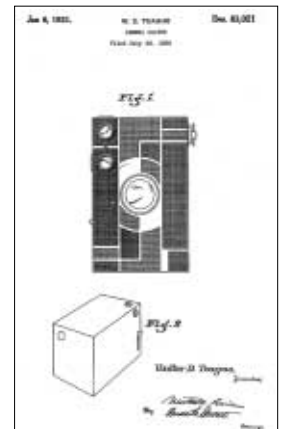

Teague Beau Brownie 1930

Design patents and design attribution practices

To understand Teague's achievements, it is important to know something about design patents and the design attribution practices of the period. Design patents cover the ornamental appearance of an object while utility patents cover the way an object works. The claim of essentially all design patents is short, simple and remarkably uniform: "We claim the ornamental design for [name of object] as shown and described." All but four of Teague's photography patents are design patents. Our use of a phrase such as "the design of a camera" is always meant in the sense of design patents, that is, in appearance and styling only, not internals.

We wanted to know which cameras Teague actually designed. From an eBay purchase we had an initial group of Teague design patents and a few related non-Teague ones. Our search of the patent literature uncovered additional design patents bearing Teague's name. We generally had some sort of patent involving each of the cameras usually attributed to Teague and had some for cameras that we had not known were Teague designs. It seemed to be relatively straightforward. Then we contacted Carroll Gantz, a well known industrial designer, a historian of industrial design and a former president of the Industrial Design Society of America (IDSA). From him we learned the standard and accepted practice until the 1950s and 1960s was that design credit for a product almost always went to the head of the design office rather than to the actual designers. Although perhaps unfair to the designers, there were legitimate business reasons for doing this – or maybe rationales – such as the client's belief that a product

ascribed to a well known designer would sell much better, and the notion that the client was paying for the design office's name and not for some unknown designer. Designers, including Dorwin Teague [11, Prologue, p. 7], complained about this practice for many years until the practice gradually changed. Even the names on design patents (based on the patent applications which are presumably legal documents) may have been influenced by this practice. Except for the significant matters of fairness, historical accuracy and proper recognition of creative work, the question to whom a patent is issued loses importance because ultimately nearly all patents are assigned to the company, either by employees or consultants. Gantz further noted that uncovering accurate design credit, with or without patents, is often a difficult and unrealizable task. In addition to the lack of records, part of the problem is that people may interpret information differently and may apply different standards of evidence. Thus, our attribution of certain cameras to Teague or any another designer might always be questioned. In Teague's case, attribution might have been further confused because his son, Walter Dorwin Teague, Jr., a designer, engineer and inventor in his own right, held extensive patents and worked for his father's firm during two separate and lengthy periods, 1934-1942 and 1952-1966.

The details of our patent search will explain what we could and could not find. We searched each of the yearly *Index of Patents* by hand to get patent numbers. Through 1934, design and utility patentees are in a single list. Starting in 1935, design patentees are in a separate list. For the 40 years 1926-1965, we looked under Walter Dorwin Teague and Walter Dorwin Teague, Jr.

We also looked under Eastman Kodak Company seeking all patents assigned to EKC by all patentees; from 1935 on, under EKC, we searched only design patentees. Why hand search? For patents before 1976, the U.S. Patent and Trademark Office website, www.uspto.gov, permits searching on few data fields. But after obtaining a relevant patent number, the website is an excellent tool for seeing a patent.

Two tables of detailed information on the Teague and non-Teague design and utility patents that we found are available from the authors. We found no relevant patents for Teague, Jr. which eliminated that potential confusion. In our discussion of cameras with a patent, the dates are usually filing dates – the time the inventors could seek protection for their creativity.

Initial contributions at Kodak

Kodak was several years behind in adding color to its cameras. For example, in 1923 Ansco introduced the No. 2 and 2A Buster Brown Deluxe models covered in red. In 1926 they marketed the Kiddie camera, similar to the Dollar, using red imitation leather.

Patents show Kodak was concerned about improved appearances before Teague started with Kodak. Even before first meeting Teague, Stuber had a 1926 design patent (see above patent) for the wavy, segmented, so-called iridescent camera covering on the Vest Pocket Kodak Model B. Norman Lehr designed the decorative patterns of the 2 and 2A Hawk-Eye Special cameras that include two Teague borders, and filed a design patent in 1926. The similar Canadian Hawk-Eye Special Six-20 has different patterns but no Teague borders. In addition, Ernest Underwood and Frank Reynolds have separate utility patents

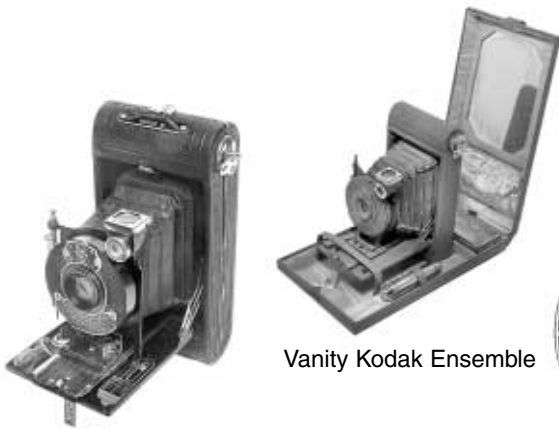

Vanity Kodak Ensemble

Vest Pocket Kodak Series III

filed in 1926 for creating attractive coverings, possibly of “contrasting colors” and “different color combinations” and for putting them on cameras.

In early 1928, Teague had limited product design experience. “His first assignment was to redesign the leather carrying case for existing camera models,” according to son Dorwin. [11, p. 22] The seemingly simple task of designing a camera case illustrates some of Teague’s philosophy, described several years later about other assignments. To buy a bulky black leather camera case from the back shelf of a camera store required a separate effort by the buyer.

By redesigning the case and having it made to match the camera, Teague made the two things a unit, so that to buy a camera without its case required a separate and perhaps greater effort, with advertising, display, and salesman’s pressure making it harder still. The sales of carrying cases increased four times over. [7, p. 28]

Teague quickly created colored and embellished versions of earlier black-only models, often using high gloss enamel. In 1928 the Vest Pocket Kodak Series III became the Vanity Kodak, and the Vest Pocket Model B became the Kodak Petite a year later as well as the Kodak Coquette in 1930. The No. 2 and 2A Brownies appeared in colors. Other repackaging and redesign of earlier cameras include the Girl Scout, the Boy Scout (USA), the Camp Fire Girls, the highly collectible deco-styled Gift Kodak and wooden box, and the Bauhaus-inspired faceplate design on the Beau Brownie based on the No. 2 and 2A Brownies. Design patent drawings indicate Teague’s hand in many of these modifications to older cameras that preceded his arrival.

More specifically, design patents by

Teague cover the Gift Kodak shutter cover, the Coquette shutter cover, the Coquette door plate, the Beau Brownie front plate, the Girl Scout door plate and the Boy Scout (USA) door plate. All six of these patents were filed July 26, 1930. A Teague sketch shows the box for the Boy Scout camera is a Teague design. The Camp Fire Girls door plate and the Kodak Six-16 and Six-20 shutter cover have Teague design patents. The shutter cover is an octagon, part of an octagon motif. Octagons abound: base of the winding knob, “film spool ends” and entire sides. All the octagons were apparently designed during the time Dorwin described as his “father’s ‘octagon period’ when he was fascinated by the eight-sided shapes and insisted on applying them to everything he designed.” [11, p. 34] Surprisingly, the body of the Kodak Six-16 and Six-20 is covered by a design patent issued solely to John Christie, a Kodak Camera Works employee (filed before Teague’s shutter cover patent was filed).

We found no design patents in anyone’s name for the covering of the Beau Brownie, for the Gift door plate and box design, or for the door plates on the Petite step pattern and the diamond door, all of which seem likely candidates for design patents. Perhaps such patents would not be worth the effort. There seems little or nothing to patent on either the Vanity Kodaks, the Petites with fabric-covered doors including those in the Kodak Ensembles, and the Vanity Kodak Model B’s in the Vanity Kodak Ensembles. The Reynolds utility patent may apply. We have no design patents for the color changes to the No. 2 and 2A Brownies which may not be patentable. Even without specific design patents, Teague’s influence seems apparent, possibly extending to inspiring others.

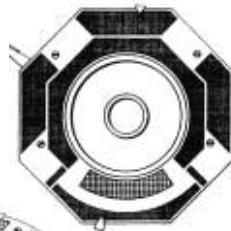

Kodak Six-16 and Six-20 shutter cover design



Gift Kodak shutter cover design

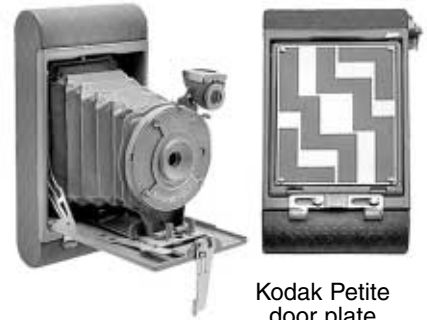

Kodak Petite door plate



Kodak Coquette door plate



Boy Scout Kodak



Beau Brownie front plate in multicolor series

Some of these cameras, such as the Beau Brownie, Petite (both fabric-covered door and step pattern) and Kodak Six-16 and Six-20, were also made in Toronto by Canadian Kodak Co., Ltd.

CAMERA PHOTOGRAPHS BY RICK SOLOWAY

CONTINUED NEXT PAGE

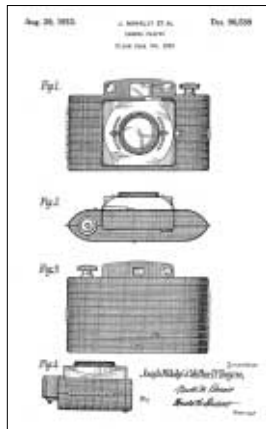

Bantam Special precursor 1933

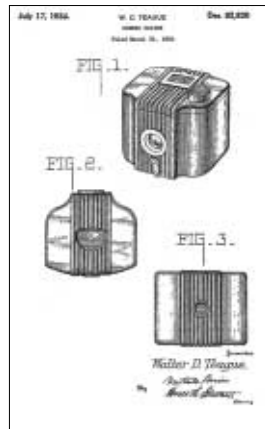

Teague Baby Brownie 1934

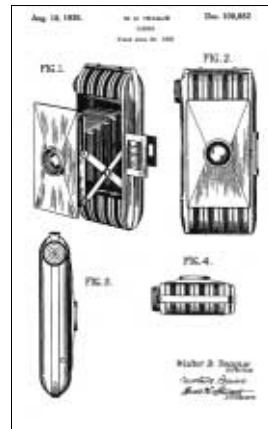

Jiffy Kodak Vest Pocket 1936

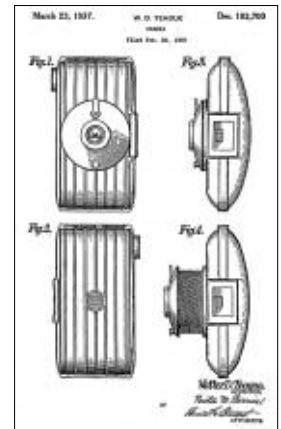

Teague Bullet (plastic) 1937

More Canadian-made cameras were the Jiffy Kodak Six-16 and Six-20, Jiffy Kodak Vest Pocket and Bantam f8 (discussed below).

For the Kodak Six-16 and Six-20, Layne suggests, “Teague was now affecting the actual shape of camera parts and bodies,” including struts [6] and its already mentioned winding knob. This is especially true of the improved version of the cameras. A design patent for the struts alone may not be worthwhile or may be precluded by the limits of a design patent. Similar struts are a small part of several utility patents by Carl Fuerst for self erecting fronts of cameras, but Teague’s role may not have justified including his name.

Teague was criticized for the “‘unfunctional’ lines of chromium along the sides of his small folding cameras.” (This may include the Kodak Six-16 and Six-20.) His vigorous response noted that “metal sides were needed to give the box strength and durability; the metal had to be lacquered, for finish, but lacquer in broad strips has a tendency to chip. The thin bands of chromium Teague used prevent chipping and are therefore an essential part of the design. They happen to be pretty.” [7, p. 28]

An ad in *Delineator*, June 1928, proclaims, “Notice particularly the fascinating cases of the Vanity Kodaks. The design was created by one of America’s leading artists, who has contrived to give the case an intrinsic beauty of its own.” The reference is clearly to Teague who is here called an artist. Teague also designed the cases for the two Ensembles.

The era of the colored Kodak cameras lasted only from April 1928 into 1934, in the U.S. at least, with possibly

a few colored stragglers still being made in 1935. Color did reappear briefly with the Kodak Starflash cameras in 1957. Teague received design patents for parts of two cameras not usually considered colored. The 1932 Jiffy Kodak Six-16 and Six-20 have a striped art-deco front. The self erecting front and twin spring struts show in John Christie’s utility patent. The part for the second camera was the 1932 faceplate for the Century of Progress World’s Fair Souvenir. Teague designed the Ford exhibit for this 1933 World’s Fair, which might explain his motivation for the souvenir camera.

Later camera designs for Kodak

Not content to be merely turning a sow’s ear into a silk purse by repackaging older designs, Teague turned to new materials and innovative designs in creating entirely new cameras. The first Bantam design patents were filed in 1933 including one for the Bantam Doublet Lens and the Bantam f6.3, two cameras simultaneously introduced in 1935. For his first all new camera to reach production, he pioneered the use of injection-molded black plastic (often termed bakelite) in the 1934 design and manufacture of the Baby Brownie. The Baby Brownie, the first Kodak camera with an all-plastic body, has been called, “Eastman’s first die cast camera.” [Quoted in 6, p. 35] Its rounded edges and corners and parallel ribbing made it definitely modernistic. The design patent designation, “DES. 92,830,” is prominently molded on its inside. Four million were sold at \$1.00 each [2, p. 85], making it perhaps one of the most ubiquitous consumer cameras of its era, and thereby assuring Teague’s status and continued success as a designer with Kodak. The Baby Brownie also provided Teague’s first photographic utility patent. Titled “Camera

Construction,” it describes a method for manufacturing cameras based on several design patents for the Baby Brownie that were never produced.

The introduction of 828 film in the early 1930s led to the creation of the Bantam line of Kodak cameras, a series designed almost entirely by Teague, as revealed in design patents with only his name. Included are the Bantam f6.3, the Jiffy Kodak Vest Pocket, the Bantam f4.5 and the Bantam f8. Significantly, there is a notable exception to solo design by Teague in the beautiful Bantam Special of 1936 designed with Joseph Mihalyi and Chester Crumrine. In 1933 Mihalyi and Teague received a design patent, Teague’s earliest non-solo patent, for what we call a Bantam Special precursor. This never-produced version of the camera lacks the later novel clamshell protector of the lens and finders but otherwise is very similar in appearance to the final version. Later in 1936 Teague and Crumrine were awarded a design patent for the Bantam Special as it was actually manufactured – a gleaming, streamlined miniature camera in black and polished aluminum. The Bantam Special has a decal inside the door listing these two design patents plus twelve utility patents. Jerome Katz writes [5, p. 29], almost certainly with information from Mihalyi, “Teague provided the designer’s final aesthetic touches that made this camera one of the most beautiful ever manufactured.” Later, on p. 75, Katz notes, “Joe said that he and Walter were very good friends and he considered Teague as probably the best design dress-up camera man available at that time.” (We interpret “available at that time” to mean “then doing designs” and not to suggest better designers were unavailable.)



Mihalyi & Teague Medalist 1941



Jiffy Kodak Six-16

Bullet New York World's Fair



Baby Brownie all-plastic



Kodak Medalist



Kodak Six-20

Other Teague designs, supported by design patents with his name alone, include the Bullet (plastic), the Bullet New York World's Fair model shutter cover and the trapezoid shaped Six-16 and Six-20 Brownie Special.

Teague's work with renowned Kodak designer and inventor Joseph Mihalyi represents several high-water marks in the pantheon of American camera design that includes the 1936 Super Kodak Six-20 (to use its official name) and the 1941 Kodak Medalist in addition to the early 1933 Bantam Special. Teague's roles in the design of the Bantam Special and the Medalist are supported by joint patents (the Medalist with Mihalyi). For the Super Six-20, Teague made a precursor drawing titled, "1937 Kodak Line," initialed "W.D.T." on October 9, 1935, and showing a one-piece clamshell door and no photoelectric cell. But we have found no patents showing his contributions to the innovative design of the Super Six-20. There could be many explanations for this unexpected omission, two unlikely ones being that we may simply have not found the design patent, or that the patent preparation

process may have been faulty. Poor relations or disagreements between Mihalyi and Teague can be excluded since they were and remained good friends. The two design patents for the Super Six-20 that we do have are Mihalyi's solo design patent for the camera and George Adams' design patent for the camera's carrying handle. Both are on a decal along with eight utility patents.

Despite no design patent bearing his name, Teague is invariably properly credited with co-designing this handsome camera along with Mihalyi in most of the literature and specifically in comments by longtime Camera Works employees David Hansen and Sam Swayze. [4] In a picture caption in *Design This Day*, Teague asserts that the Super Six-20 design is his. He certainly followed the then accepted practice for design attribution. Possible co-designers are included only by a note in the acknowledgments thanking "my staff of co-workers for their constant, loyal aid and support" and then naming six from his design firm. [13, first edition] Kodak co-designers seem not to be remembered.



Bantam Original f6.3



Bantam f8



Bantam f4.5



Bantam Special

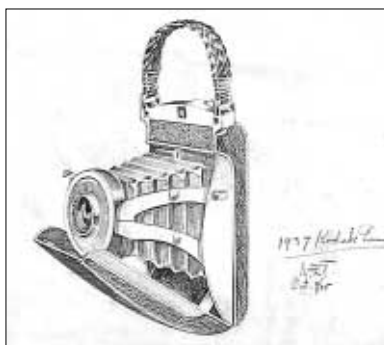

The Joseph Mihalyi 1936 patent and Teague's precursor drawing for the elaborate Super Six-20 which bears Teague's initials. The double clam-shell cover hides the collapsing lensboard and bellows. Drawing image courtesy of George Eastman House.

CAMERA PHOTOGRAPHS BY RICK SOLOWAY

CONTINUED NEXT PAGE

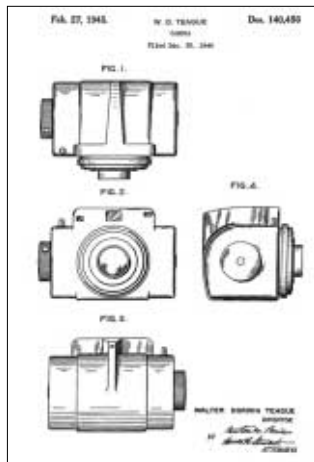

Teague Two-Film Camera 1944

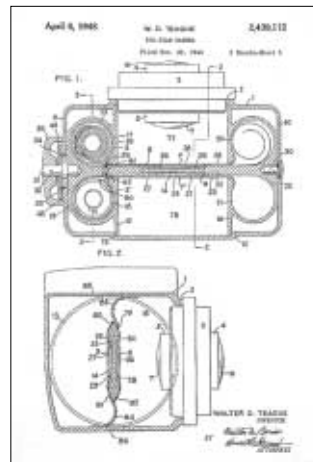

Teague Two-Film Camera 1944

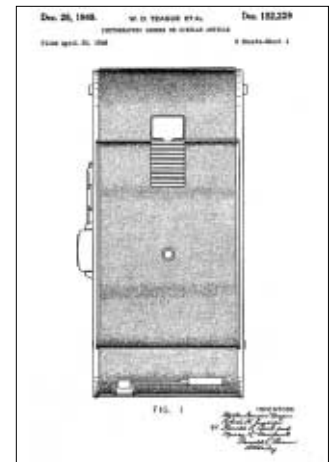

Teague et al. Polaroid Model 95 1948

The Baby Brownie Special's design story is similar to that of the Super Six-20. While Chester Crumrine has a solo design patent for the Baby Brownie Special, Teague contributed a precursor drawing dated April 8, 1937 with his name. The drawing differs in three ways from the camera as produced: the shutter release is on top, no latches on the sides, and a long "string-like" carrying handle.

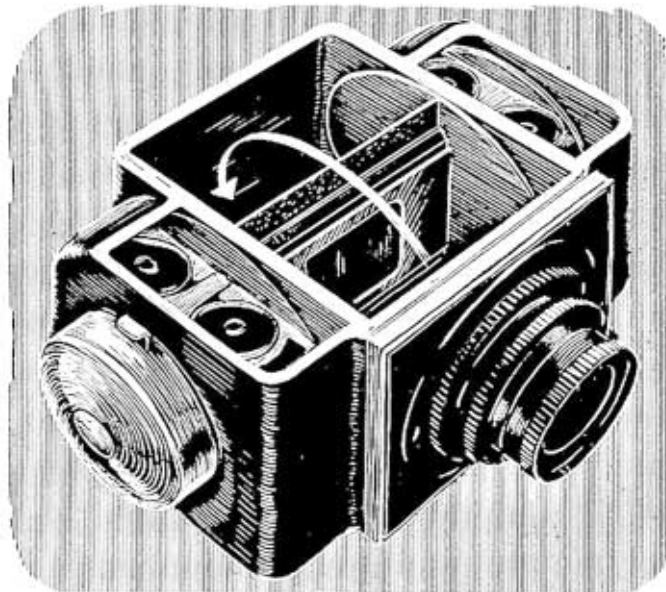

Teague's last two Kodak patents, and his only Kodak ones after 1941, are the design and utility patents for a two-film camera. Both patents were filed on Dec. 30, 1944 and were issued February 27, 1945 and April 6, 1948, respectively. They are for a clever and certainly unusual camera that was never produced.

Teague's two-film camera which allows intermixing of exposures on two rolls without changing the rolls. Each roll of film starts at one side of the camera, ends at the other while traversing the novel rotating film plane. From *Popular Science*, August, 1948, p. 82. Image courtesy of Walter Hughson.

After the Medalist collaboration, Teague may also have been involved in the design of the renowned Ektra with Mihalyi who has a solo Ektra design patent. There are similarities between the two cameras. The Six-20 Bull's-Eye could be Teague's, too. Since it can be viewed as combining aspects of the Baby Brownie and the Six-16 and Six-20 Brownie Special, those two patents may suffice. We do not know the designers of the front plates on such cameras as the Six-16 and Six-20 Brownie, Brownie Junior, Target Brownie and Brownie Target.

As might be expected, not all of Teague's design patents resulted in manufactured cameras essentially as drawn. We have already noted the Bantam Special precursor and the two-film camera. Eight designs were filed on April 6, 1935, and all were issued on July 23, 1935 as consecutive patents. One resembles the Bullet, one resembles the Bantam f8, four resemble the Baby Brownie but were not made, one with two protruding circular film spools was unmade, and one of trapezoid shape is unidentified.

Contemporary to Teague's tenure at Kodak are other cameras which, judging by patents, are not his designs. These include the Brownie Reflex by Henry Drotning and the Duaflex by Miller Hutchison, Jr. More surprising is John Nelson's shutter cover on the Baby Brownie, New York World's Fair model.

With Kodak after World War II

In this period Teague's role at Kodak changed. Hansen and Swayze remember no Teague camera design after the mid-1940s [4], and we found no evidence of specific Teague camera designs for Kodak after 1944. Spending one week a month in Rochester likely had ended by the early 1940s, perhaps sooner.

Arthur Crapsey, Jr. recalls, "In 1946 or 1947 Teague was retained as consultant to the Industrial Design Group being formed under Ted Clement" that already included Crapsey. Fred Knowles and Ken Van Dyck soon joined. Through at least 1958, "Teague was visiting us on a regular basis two to six times a year depending on perceived need as management saw it." [1] Gantz gives an earlier start date, which is probably accurate, and a subtly different relationship: "In 1945, Kodak established its own design department, headed by Theodore Clement working as assistant to Teague, who continued as a consultant." [3] Hansen, a Kodak industrial designer who started at Kodak in August 1957, remembers three or four Teague visits "to Camera Works to mainly give design credibility for the Kodak design work to engineering management." [4]

Teague might have helped or inspired other designers to create post-war designs. From 1948 to 1958 Crapsey produced a long list of design patents that includes the Brownie Hawkeye (150,289 and 151,965), Bantam RF (173,411), Ponys and Signets; he might also have done the 1953 Chevron. [9] Teague's death in 1960 was a great personal loss to him. Some people might quickly decide that a few of these postwar designs were

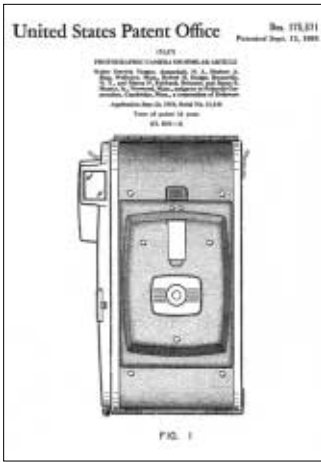

Polaroid Highlander 80 1954



Polaroid Highlander 80

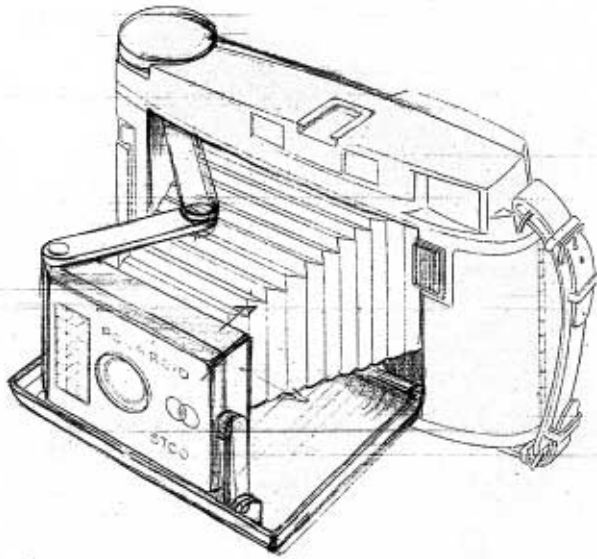

Teague also played a major role in the early design of Polaroid Land Cameras. 1959 design drawing by Walter Dorwin Teague Associates for Polaroid showing features never produced. Drawing image courtesy of Benson Ford Research Center.

done by Teague himself. Several websites incorrectly credit the Brownie Hawkeye to Teague.

Designing for Polaroid

Teague's camera designs were not limited to Kodak. He also played a major role in the early design of the Polaroid Land Cameras. A simple breakdown is now possible of all of our Teague patents, by filing date and client: All patents from his first in 1930 to 1944 were for Kodak. All patents from 1947 to his last in 1960 were for Polaroid. (He filed none in 1945 and 1946.)

Design patents for Polaroid cosigned by Teague involve the Model 95 in 1948, the Highlander Model 80 from 1954, and a posthumously issued patent in 1961 for the 1960 Electric-Eye 900. One of Teague's design office partners, Robert Ensign, is another cosigner on these three

patents. Teague also received a joint utility patent, issued posthumously, for a latching mechanism and a shutter release on the 850 and 900 models. In the 1949 second edition of *Design This Day*, Teague replaced the picture of the Super Six-20 with one of the Model 95 and now asserted the Model 95 design to be his. His only acknowledgment this time is to unnamed associates who "have contributed immensely." [13]

The Teague office made a series of drawings for Polaroid showing new drop-bed designs, top plates and focusing knobs that apparently never appeared on marketed cameras. Dorwin Teague's drawing for Polaroid dated January 1959 shows a "focusing drive linear hinge system" for the 850 and 900; on his projects list for 1958 [11, Appendix, p. 229] is

"new erecting system" for Polaroid. For Leitz in April 1974, Dorwin Teague, now head of Dorwin Teague, Inc., worked on the 50th anniversary box for the Leicaflex.

Gantz tells of an early relationship between Teague, Edwin Land and Polaroid. In 1939 Teague's office designed an executive desk lamp for Polaroid. "The design was very successful, and convinced Land of the value of not only industrial design, but of Teague's office in particular." [3] Dorwin Teague was also involved with this lamp.

The Teague legacy

Walter Dorwin Teague's camera work for Kodak can be viewed in several phases. He first added color, including coverings, and designed various shutter covers, door plates and front plates to other current cameras. Then he at least suggested functional parts of cameras, such as the struts, knobs and metal sides

of folding cameras. Next he designed entirely new cameras, sometimes in collaboration with Kodak designers and inventors. Finally, he reviewed the designs of others for management.

In addition to the numerous still cameras, Teague's design activity in his many years for Kodak widened to include motion-picture equipment, packaging materials, images and marketing strategies, display rooms and offices, interiors for Eastman Kodak stores, manufacturing facilities and their 1939 World's Fair exhibit. According to Crapsey, the old visitors lobby in Camera Works is Teague's. [1] His byline appeared in Kodak publications. For the Rochester home of the Adolph Stubers, he even designed some of its interior and furniture.

It appears that Kodak received its money's worth from its long association with Teague. Certainly, the initial goal was achieved quickly since Kodak cameras did get the sought after improved appearance. Then, new and beautiful cameras emerged from Teague's creative solo and joint designs. He apparently inspired the design of other Kodak cameras as well. Sam Swayze observed in 1988, "By the mid-thirties, he had learned enough about mechanics, materials, and processes, that he was able to produce designs with the sophistication and elegance of the handsome Super Six-20." [10] And Teague did continue to receive design assignments from Kodak, including ones for packaging materials and images.

In return, Teague benefitted significantly from his Kodak association and achievements. Two highlights quoted previously from Dorwin Teague demonstrate this: the very substantial initial fee helped in dealing with other clients, and the success of the Baby Brownie assured the future of his father's industrial design business.

Eastman Kodak Company and Polaroid are the two camera companies for which Teague designed. The list of other client companies and products associated with Teague and his design office is truly impressive. A small sampling of companies: Boeing, A.B. Dick, Dupont, Ford, National Cash Register, Texaco and U.S. Steel. A few specific products: pocket lighters, pyrex ovenware, radios, Scripto pens, Steinway pianos and Stueben glass. At the U.S. Air Force

CONTINUED NEXT PAGE



A late 1950s snapshot of Teague holding a Brownie Starflash with, from left, Arthur Crapsey, Fred Knowles and Dave Babcock. Photograph courtesy of George Eastman House.

Academy, Teague and his associates did much interior design work. Teague is sometimes discussed together with three other famous contemporary industrial designers: Henry Dreyfuss, Raymond Loewy and Norman Bel Geddes, the first two of whom also designed cameras. [9]

Just as Thomas Edison's greatest innovation may have been his creation of the modern research laboratory as we know it today, Walter Dorwin Teague was a pioneer in the creation of the modern day industrial design firm, developing a new profession by merging the aesthetic sensibilities of the world of art with improved technologies, engineering skills and modern manufacturing processes to the benefit of a thankful and appreciative modern society. Teague's camera designs are a fascinating and important part of his design legacy. ✪

Acknowledgments

We are grateful to the many people who generously supplied us material and information: Merle Carey, Carroll Gantz, Terry Hoover (Benson Ford Research Center), Jean Judd, Charlie Kamerman, Eaton Lothrop, Jim McKeown, Nicolette Schneider (Syracuse University Library), and especially Todd Gustavson (George Eastman House). Our special thanks to Teague grandchildren Allison Teague, Harry Teague and Walter Teague, III. Bobbi London and Cheryl Soloway supplied excellent research assistance and adroit editing skills; Cheryl visited the Benson Ford Research Center for us. George Layne, Eaton and Milan Zahorcak carefully read a previous draft. Paul Garrett and Charlie graciously helped us to photograph cameras and other items in their extensive collections. Paul was also the matchmaker for our collaboration

References

1. Arthur Crapsey, Jr., Transcription dated May 10, 1988 of handwritten notes in response to request to summarize the history of industrial design at Kodak, 2 pages.
2. Carroll Gantz, *Design Chronicles*, Schiffer, 2005.
3. Carroll Gantz, 100 Years of Design, Industrial Design Society of America website. <http://new.idsa.org/webmodules/articles/anmviewer.asp?a=51&z=23>
4. David Hansen and Sam Swayze, emails, February 7-8 and March 15, 2006.
5. Jerome Katz, *The Joe Mihalyi Story*, Second Edition, SJF Enterprises, 1978.
6. George Layne, "Art Deco Kodaks," *Proceedings of the First Western Photohistory Symposium, May 16, 1980*, W.P. Carroll (ed.), 1981, 33-46.
7. Gilbert Seldes, "Profiles: Industrial Classicist," *The New Yorker*, December 15, 1934, 28-32.
8. Mary Siff, "Realist in Industrial Design," *Arts and Decoration*, Vol. 41, Oct. 1934, 44-48.
9. Rick Soloway and Ralph London, "Some Camera Designs of Arthur Crapsey, Henry Dreyfuss and Raymond Loewy," *Photographica Digest*, Western Photographic Historical Society, 2006, to appear.
10. Sam Swayze, "History of Industrial Design at Kodak 1927-1986," November 22, 1988, 8 pgs.
11. W. Dorwin Teague, *Industrial Designer: The Artist as Engineer*, Armstrong World Industries, 1998.
12. "Walter Dorwin Teague: Dean of Design," *Printers' Ink*, January 30, 1959, 81+.
13. Walter Dorwin Teague, *Design This Day: The Technique of Order in the Machine Age*, Harcourt Brace, 1940; Second Edition 1949.

Ralph London (London@imagina.com) collects mainly early wood and brass cameras from the 1840s to the early 1900s plus relevant catalogs and ads. He and wife Bobbi have created a display at each Puget Sound Photographic Collectors Society annual show since 1993 when displays began. They have many of Teague's cameras. A retired computer scientist living in Portland, Oregon, Ralph contributes frequently to photo history publications. For many years he edited the Cascade Panorama for the Cascade Photographic Historical Society. He also maintains an extensive topical collection of postage stamps on cameras and photography.



Rick Soloway (ricksoloway@hotmail.com), born and raised in Detroit, graduated from Wayne State University with a concentrated study in the History of Science. Since graduation, he has been a commercial photographer specializing in images for the biomedical sciences. His work has been published in numerous medical journals, textbooks and atlases. Rick's collecting interests include streamline/deco era camera designs as well as compact, miniature and subminiature cameras. Now living in Tucson, he is treasurer and a member of the board of directors of the Western Photographic Historical Society.



“CANADIAN MADE” TEAGUE ERA CAMERAS

The 1930s and 1940s offers an opportunity to assemble a unique collection of “Made in Canada” photographica. Bill and John Kantymir have, within their wide ranging collection, assembled Kodak produced cameras of the *Art Deco* period which may tie to industrial designer Walter Dorwin Teague (see *limitations in previous article*). The uniqueness lies in the outer packaging which bear elements different to American counterparts and must have been produced in Canada. As a result accessories such as boxes and manuals, in many cases, can be more valuable than the camera.

It is somewhat suspect that any Kodak camera labeled “Made in Canada” can truly live up to that claim – they were assembled from parts produced in the United States. To meet

Canadian Tariff regulations, minor assembly was performed then packaged in the Canadian box (hopefully to reach a 10% content requirement).



NAME PLATE FOR SIX-16 KODAK



KHAKI BOY SCOUT KODAK WITH CASE & MANUAL AND GREEN GIRL SCOUT KODAK



SUPER KODAK SIX-20 WITH CASE AND INSTRUCTION MANUAL



BAKELITE BABY BROWNIE WITH CARTON

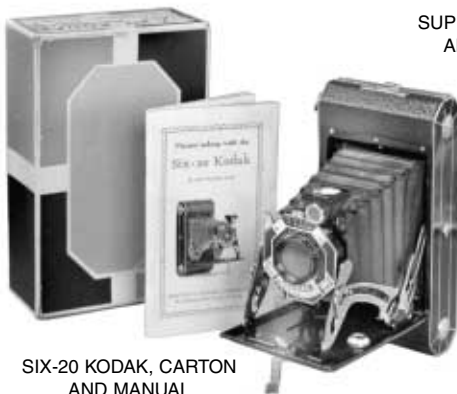

SIX-20 KODAK, CARTON AND MANUAL



BAKELITE BULL'S EYE SIX-20 WITH CARTON



BROWN KODAK JUNIOR SIX-16 WITH ART DECO CARTON



KODAK EKTRA WITH TWO EXTRA LENSES & COVERS, MANUAL AND MAGAZINE BACK



ANNIVERSARY KODAK AND CARTON



NO. 1A GIFT KODAK IN BROWN WITH WOODEN PRESENTATION BOX, MANUAL AND ART DECO CARTON



BANTAM SPECIAL IN FOLDED AND OPEN POSITIONS



RARE PINK BEAU BROWNIE AND CASE

As Reported by George Dunbar....

Browsing through our Exchanges

• publications from photographic societies are received and reviewed for your interest. To borrow items or collections, contact Librarian Gerry Loban - phone (905) 477-3382.

Photographica World, No. 117, 2006/3 of the Photographic Collectors Club of Great Britain reports in its latest issue:

In 1955 the BBC began a TV program dedicated to photography and used a folding camera (Kodak Sterling II) as a demonstration prop. Since the BBC didn't allow the mention of brand names the camera was renamed 'Katie.' The history of that program (*Have You a Camera?*) and details of the folder make for an interesting story.

Experimenter Bill Hodgson describes his procedures to create a working camera from Lego blocks - an amazing feat! In fact, he features three different Lego cameras in this article along with beautiful results from the unique instruments.

The story of a couple of photographers who, in 1856, challenged one another in the same neighborhood is told in this article (The Battle of Station Street) which includes some of their newspaper 'attack' ads.

Plenty more in this fine 44 page magazine.

The Daguerreian Society Newsletter, May-June 2006, Vol. 18, No. 3 brings news of many collections and auctions and a report of the *Spring Workshop* in Pittsburgh.

In a featured article (*What's Old Is New Again, Photography 1968*) Walter A. Johnson relates the organization and events leading up to "*The First Conference and Workshop of the Society of Photographic Collectors of North America*" at Ohio State University - interesting piece of history.

The Daguerreian Society Newsletter, July-August 2006, Vol. 18, No. 4 runs members' portfolios which include fine reproductions and descriptions of

images. The "*Enigmas/Queries*" pages are always intriguing, particularly the image containing a legible newspaper fragment. Many collectors will appreciate the helpful feature, "*Storing Your Collection.*"

Back Focus, August, 2006 the Journal of the Australian Photographic Collectors Society. In commemoration of Voigtlander's 250th anniversary (dating from 1756) we have a fine history of the company and many of the products.

An extremely interesting autobiography (*A Collector's Story*) by Herb Parker, tells of life in China during the World War and Civil War. He describes his collecting adventures that were begun in Hong Kong and continued on through Singapore and later Australia. There are many other articles including "single use cameras."

Stereo World, July/August 2006, Vol. 32, No. 1 of the National Stereoscopic Association brings before us a history of "*Stereo Pair Illustrated Books*" which presents many unusual publications and the associated viewers. An amazing article tells of the "biggest hyperstereo camera in history" which consists of two identical satellites being manufactured by NASA and intended to observe the Sun's atmosphere in three dimensions. The theory behind the Solar Terrestrial Relations Observatory (STEREO) is explained and illustrated with photos of the testing at the Goddard Space Flight Center. Additional information is on the STEREO web site at www.nasa.gov/stereo.

The number of 3-D feature film productions continues to increase. Listed here are more than 50 film titles, including the suggestion that "all six Star Wars films are being converted for 3-D release."

Stereo World's Sept./October issue: An extensive account of German naval activities is given in "*Kriegsmarine - Life in Hitler's Navy*" (c. 1941), accompanied by 22 B&W stereo pairs of ships and personnel. This article is based on military-themed stereo books published by Otto Wilhelm Schonstein.

The Strange Case of Dr. Addison and the Crosswell Twins is the illustrated story of a photographer who, in 1908, insisted that he had photographed a ghost.

The Photogram, July 2006, Newsletter of the Michigan Photographic Historical Society contains a very interesting biography of Warren Coville, a collector and exhibitor of photography and philanthropist (he started a Kodachrome processing facility c. 1956).

The Photogram Sept./October issue brings forth a description of the invention of the Kinnear cameras ("*small size, large format*") by a Scotsman, Charles George Hood Kinnear in 1857.

Zeiss Historica, Spring 2006 of the Zeiss Historica Society includes with this issue: articles on the Tenax camera and the Triotar lens which will interest many collectors. The feature, titled "*The Early Observatory Telescopes of Carl Zeiss,*" will certainly capture the imagination of anyone interested in astronomy - wonderful photos of gigantic telescopes.

Nikon Journal, June 30, 2006 of the Nikon Historical Society offers: "*Complete coverage*" of the recent Nikon Convention/10 in Vienna and is illustrated with dozens of photos and was declared "Awesome!"

Nikon Journal, Sept. 30, 2006 issue contains an extensive article describing the Nikon F3 including different models of camera, finders and other accessories. A fine explanation of the manufacturing process and dozens of photographs of the many configurations.

Canadian Camera, Vol. 7 No. 3, Fall 2006, official publication of the Canadian Association for Photographic Arts, continues to educate its members and subscribers with photo layouts of interesting topics. More articles deal with digital information: Digital Camera Workflow, Converting from Colour to B&W, Montage: Get a Digital Glow On.

Ask Librarian Gerry Loban for collect- ed issues of these interesting journals.

TOURING THE PHSC FALL FAIR

by Mark Singer

Our Fall Fair in Woodbridge was held for the first time in many a year, after the Thanksgiving weekend. We had a total of 102 tables of bargain goodies with 5 free tables given over to educational displays – courtesy of Robert Gutteridge, Francois LeMai who came in from Montreal, the Toronto Camera Club and U&I magazine. Our attendance was down somewhat due to competing shows but we were compliment-

ed as being the better one. Ed Warner, Tony Fernandes and Win Morris were cashiers at the front. Clint Hryhorijiw collected from late tableholders. Thanks to the security people who helped in many ways: Egon Kellner, Julian Morasutti and Tiit Kodar. Wayne Gilbert recruited new members at the PHSC booth while Bob Lansdale photographed. β



Ticket dispensers Win Morris, Ed Warner and Tony Fernandes greet visitors.



An interesting story indeed here as Jack Arno and "Neil" exchange hernia details.



First entrants were met by Julian Norasutti, Egon Kelner and Tony Fernandes.



Francois LeMai, Montreal exhibited classic cines.



Shelton Chen's Canons with f0.95 50mm lenses



Bill Kantymir's 1/16 plate "Babbitt" Niagara dag.

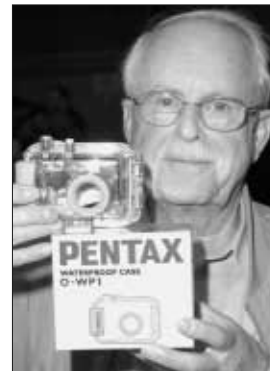

John Bock showed Pentax water proof case.



Judy Rauliuk with an enticing display of folders.

PHOTOGRAPHS BY ROBERT LANSDALE



John Morden and son Josh show an interest in a 6x9 Mentor Reflex camera.



Robert Gutteridge displayed his collection of rare cine cameras to Edward Dunbar.



Visitors crowded the tables from 10 AM opening to find prized collectibles.



Derek Dalton at our shows presents two tables full of images – all types, varieties and sizes.



Karl Wright always has a wide selection of camera gear to search through.



Mark Singer at the end of the day as last minute table holders pack to leave.

A Photographic Tour of PhotoHistory XIII in Rochester

Photos by Robert Lansdale

Another successful PhotoHistory symposium is wrapped up and consigned to our memory archives. We certainly appreciate the continuing energy of our sister society in Rochester, The Photographic Historical Society, for having assembled so many top speakers in photographic history and combined their presentations with a wonderful Trade Show as well as a social banquet. We doff our hats to the dedicated

workers of TPHS in Rochester and to the hosting George Eastman House.

Almost 200 photohistorians from 22 States and 7 foreign countries assembled for the three days of information exchange. The programs were most interesting with top-of-the-line researchers coming from varied fields. The symposium was the ultimate in education – I think the word would



The scene in the Dryden Theater as the symposium kicked off for its thirteenth time. Nearly 200 registrants attended, representing seven different countries. They heard 15 scholarly and fascinating illustrated talks by top photo experts.



In the Curtis Theater Carole Glauber makes her presentation on the influence of Eva Watson-Schütze to Pictorial photography and the avant-garde in support of Alfred Stieglitz. Both theaters were used to accommodate all speakers.



Grant Romer gave insights to early Wolcott camera.



Terry Bennett, UK, expert in Japanese photo history.



Regine Thiriez, Paris, talked on Shanghai photography.



Nick Graver lectured on literature in every form and format.



Rick Soloway revealed W. Teague influence on Kodak



Michael Pritchard analyzed British photographic patents



Ralph London co-lectured on Walter Teague & Kodak



Terry King, UK, reconstructs early photo processes.



Jim McKeown reported on camera collecting market.



Philip Storey brought images of early street photography.



Carole Glauber connected Eva Watson-Schütze to Stieglitz



Eaton Lothrop's topic wet-plate street photography.



Bill Becker explained history of Spirit photography.



Daile Kaplan, showed new trends in collecting photos.



Some \$30,000 of Stieglitz books, courtesy of Kodak, went to registrants and draw winners.



Jack and Beverly Wilgus of Baltimore set up their exhibit of working Camera Obscura in the garden.



Happy are the draw winners of the special twin-set Stieglitz books valued at \$300.



Canadians were fairly well represented at the symposium with PHSC attendees mainly from Toronto. In the group at left are: the Gerry and Pauline Loban, Kathy Kinakin from Vancouver, Felix and Yolanda Russo, Lorraine and Bob Wilson, Judy Rauliuk and Les Jones. Also noted from Canada were Bill Kantymir, Ian and Joyce Archer and Ron Chappell from Vancouver.

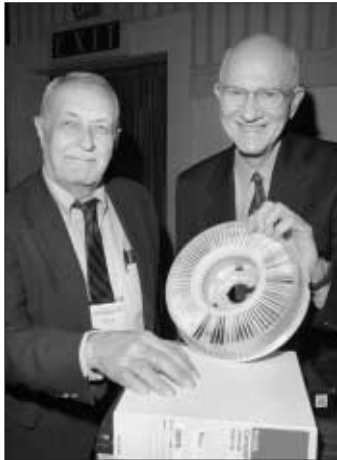

E. Lothrop and N. Graver prefer slide shows over digital Power-Point.



The GEH garden was setting for working Camera Obscura exhibit.



Canadians Felix Russo and Bill Kantymir before Dryden Theatre.



Les Jones compares notes with Kathy Kinakin from Vancouver.



The Trade Show brought forth a variety of materials and collectibles which are seldom seen in our own areas. Therefore it was an exhilarating experience to hunt for new acquisitions.



Ian Archer of Toronto gets reaction from wife Joyce showing Premo to Twinkle and Bill Riley.



Seductive display of red bellows and rose wood cameras by Barbara and Peter Schultz of R.I.



Kaoru Kuraishi of Japan discusses daguerreotypes with dealer Harvey Zucker of New York.



Visitors came from Canada, Germany, United Kingdom, Japan, Belgium and the Netherlands.

be "intense" and it is a shame that others (in even greater numbers) could not participate and enjoy.

The Trade Show had offerings by 62 dealers who journeyed from a wide area of the United States. It definitely provided the opportunity to revue "fresh" collectibles after having worn out our own local shows over so many years.

Those attendees who arrived early were given a special behind-the-scenes tour of the George Eastman House and its storage archives as well as touring the present exhibits.

The symposium has been held every third year since its first courageous assembly in 1970; this was the 13th of the series. Jack Bloemendaal

(Mr. Energy) has chaired seven of the thirteen symposia. Other committee members were Sharon Bloemendaal who arranged the Program and created Publicity, Frank Calandra who handled the Finance, Marian Early took care of Registration while Tim Fuss chaired the Trade Show. To you all, many thanks.

Toronto Notes

reported by Robert Carter

In the fall of 2002, Toronto hosted an exhibition of photojournalism from around the world. The exhibition was brought here through the efforts of our October speaker, Lesley Sparks.



Lesley Sparks speaks to the PHSC.

The World Press Photo exhibition features the best of the previous year's news photographs. An award in this exhibition is considered to be the Oscar of photojournalism. Based in Amsterdam, World Press Photo receives support from the Dutch Postcode Lottery and is sponsored worldwide by Canon (cameras) and TNT (global express). Since 1955, this annual exhibition of prize-winning photojournalism has brought world affairs and news to people worldwide, especially in countries without access to news events of the day. An illustrated catalogue gives added information on the WPP and the photographs and photographers. Currently the travelling exhibition reaches over 2 million people in 40 countries.

Lesley began her presentation with background information on herself and the WPP. In her introduction, Lesley noted a long time interest in photography dating back to her childhood in London, Ontario. She felt that photography offered equal opportunities to both girls and boys. After high school, she was attracted to Toronto and Ryerson before returning home to complete her post secondary education at Fanshawe College. Around 1980, she sent her resume to Kodak in Toronto and was hired - in the mail room. Lesley performed a variety of jobs at Kodak over the next half dozen years, working at documentary photography (her prime interest) in her spare time.

She was in Kodak's Marketing Information centre around 1989 when teachers began contacting Kodak for school programs. Lesley accepted the challenge and became Kodak's prime contact for school programs. This job ended in 1997 when Kodak decided to cut all education programs. Lesley left Kodak, and worked with CONTACT, the annual Toronto photography show, which was just starting up.



Tiit Kodak videotapes proceedings.



Felix Russo and Ed Warner thank Lesley.

In the late 1990s, France hosted outdoor projection nights in late August and early September. The 2001 program featured a series of images on Afghanistan. The three story high projected images left a strong impression on Lesley. On her flight back home, one fellow traveller was wearing a burqa. The flight landed in Montreal on September 11th amidst some confusion. Lesley was unaware of the New York tragedy until next day.

Realizing the gap between the North American view of the world and what was happening elsewhere in places like Afghanistan, Lesley was determined to bring the World Press Photo exhibition to Toronto. The following year, she lined up the Globe & Mail as a sponsor and secured the

Atrium at BCE Place as a venue for the WPP 2002 exhibition in October, 2002, personally covering the last part of the expenses.

Her efforts were nearly lost through a single negative incident. One of the tenants in the building ran a fire drill during which an employee was offended by a picture taken at the World Trade Center on 9/11 of a body falling past the windows of the doomed building. Neither Lesley nor Brookfield, the company managing BCE Place, was informed of any complaints. Instead, the person contacted the National Post gossip columnist and next morning's Post had a column headline "BCE PLACE IN BAD TASTE."

Brookfield asked her to remove the offending image but under the terms of the exhibition removing any print meant closing the entire show. That night Lesley emailed all those on her contact list and requested their help. Brookfield was flooded with supportive emails and withdrew their request.

The following year started even worse. Lesley was short of funds, SARS hit the city and Toronto was wracked with cancelled events. In this turmoil she received a call from Brookfield offering her the Atrium again, but also offering to cover any shortfall in her funding.

The 2004 exhibit was in good financial shape. Now sensitive to controversial images, such as the decapitation shown by one Liberian photograph, Lesley arranged for a small enclosed "room" with a prominent poster warning visitors about the images on display inside.

An ad agency helped with the 2005 show. Sponsors were lined up and an 8 page colour brochure was printed to give the viewing public information they could take home. Mixing news images and sponsors proved to be a delicate task. Lesley gave us behind the scenes anecdotes on the efforts taken to ensure the exhibition cover shot didn't compromise or contradict the sponsor's back page ad and vice versa.

Of 83,000 photos submitted by 4,500 photographers for this year's show, the "World Press Photo of the Year" was taken by Canadian photographer Finbarr O'Reilly of Reuters. ♣

READ THE WHOLE STORY AT WWW.PHSC.CA

The Daguerreian Symposium in Pittsburg

by Robert Lansdale

Members of the Daguerreian Society and visitors gathered in Pittsburg, PA from November 16 to 19 for the eighteenth annual Daguerreian Symposium. Some 126 attendees gathered from all parts of the United States as well as England, Canada and Japan.

In addition to the day and a half of educational presentations by some eight speakers there was also the Trade Show with a room full of daguerreotypes, ambrotypes, paper images, memorabilia and a few cameras. For social events a trip to Fallingwater exposed everyone to

the famous Frank Lloyd Wright landmark followed by a reception at the new Daguerreian head quarters/museum. A banquet and image auction was followed by the annual business meeting. Mike Robinson of Toronto took a daguerreotype portrait of the assembled group.



First time for Geoff and Viv Preece of Cheltenham, UK also Jack and Beverly Wilgus of Baltimore, MD.



The educational meetings attracted visitors from all States, Canada, England and Japan.



A reception was held the first evening to view exhibits in the new headquarters.



Speakers covered a wide variety of topics. Mark Koenigsberg and M'Lissa Kesterman.



The group arranges itself before the hotel for its annual five-second daguerreian portrait.



The Gold Rush and a family album were topics for Michael Rossi and Jane Turano-Thompson.

PHOTOGRAPHS BY ROBERT LANSDALE



Canadians Felix Russo, Mike Robinson and Bob Lansdale



Rob Lisle explains details of dag cameras to Donald Dow.



Mike Robinson took annual Daguerreotype of group.



Viv Preece, UK and Alvin Moss, NY discuss images.



Len Walle's bid won Brooklyn Bridge by Jerry Spagnoli.



The Trade Show is always a favorite afternoon to seek images from top U.S. dealers.



Visualize dozens of tables carpeted with glittering daguerreotypes such as these.



Modern daguerreotypes were also offered as well presented framed art pieces.

Taking Colour Photographs with a 100 Year Old Kodak

by Alldyn Clark

Several Years ago at one of our Photo fairs I came upon a box camera that les Jones was selling. It happened to be a No. 3 Kodak Brownie Model B box camera and it was in mint condition including the original Kodak Instruction booklet. I was quite content to hand over \$25.00 at the time for what I considered a real prize item.

—something it could not do when it first came on the market in 1908 and colour roll film was not yet available.

I planned to use Kodak 120 colour negative film at ASA 160 but how to accommodate the 2 1/4" wide film to the wider 3 1/4" spool and frame.

an unexposed roll of 120 film onto an empty spool. (This can be done in a regular camera but making sure you cover the lens while shooting and advancing the film). The paper leader is then fed into the slot of the empty 124/120 spool and in the dark rewind onto that spool.

In room light, I then loaded this spool into my altered camera, advancing the paper cover until I could just see the first set of arrows coming out of the rolled up film. The camera was then closed up securely; the red window having been blocked off with black and tape. I advanced the winding knob seven complete turns, bringing the knob to the same clock position each time. I was ready for picture number one. After each exposure I advanced the film by winding the knob two complete turns until six pictures had been taken.

Back in the dark-room the film had to be rewound to an empty 120 spool ready for shipment to my film lab.

In taking the pictures and checking with a light meter I found that bright sunlight required the smallest opening of f/22 at the fixed shutter speed of 1/30th second – easy for hand held shots. With the camera on a tripod I was able to take flash shots with the open shutter system. A fast open – flash – and close was worked out.

The Kodak No. 3 Brownie Box Camera bears a patent stamp of 1894 to 1902 and was introduced to the market in 1908. It has a single element Meniscus Achromat lens and a Rotary shutter. Minimum focus is five feet. The original price for the camera was \$4.00.

For something out of the ordinary, try making these old cameras work again – it will give you much satisfaction.

For additional information contact me at alldyn@sympatico.ca



ALLDYN CLARK

PHOTOGRAPHS BY ALLDYN CLARK



The No. 3 Kodak Brownie



A colour image by Alldyn Clark from his Kodak Brownie



With the new spool in place and mask at film plane.



The film fed over the back to the take-up spool.



Two film spools with collars to convert from 124 to 120.

The camera became a fixture on my mantle piece for quite some time until I decided to see if it could be reactivated taking pictures. But alas there was no such film available in the 124 size which produced 3 1/4" x 4 1/4" images. I, at least, tried some tests by loading the camera in my darkroom with test sheets of enlarging paper, cut to size. With the camera on a tripod I made a time exposure of several seconds in bright sunlight, then processed it in paper developer to get a negative print. From that I produced a contact print to another sheet of paper ending up with a fairly good positive.

But I yearned for something better. I wanted to take colour photographs with this almost 100 years old camera

I had an extra spool and together with the one that came with the camera I set to work to remove the outer metal rims using two gripper pliers to slowly twist them off. Then from the end caps of two (plastic) 35mm cassettes I produced reducer-rims by enlarging their holes with a reamer just enough to fit snugly to the wooden shank of the 124 spools. I eased them into place then re-applied the outer metal rims and glued them securely. Both spools were handled the same way.

Then I cut a cardboard mask to the new film size and applied it to film plane at the back of the camera. I was almost ready to take my first pictures.

But first I had to prepare a new roll of film. In total darkness I first wound